

3

LAMS-2959

CIC-14 REPORT COLLECTION  
REPRODUCTION  
COPY

**LOS ALAMOS SCIENTIFIC LABORATORY**  
**OF THE UNIVERSITY OF CALIFORNIA ○ LOS ALAMOS NEW MEXICO**

---

HEALTH PHYSICS PLANNING FOR A HIGH-PRESSURE  
TRITIUM GAS EXPERIMENT AT A UNIVERSITY

LOS ALAMOS NATIONAL LABORATORY



3 9338 00310 7041

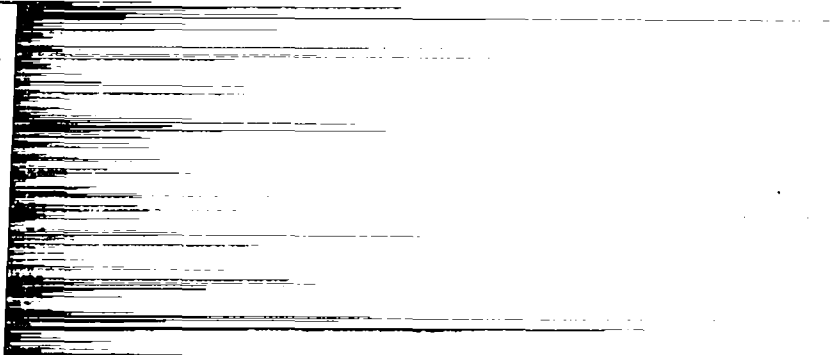

## LEGAL NOTICE

This report was prepared as an account of Government sponsored work. Neither the United States, nor the Commission, nor any person acting on behalf of the Commission:

A. Makes any warranty or representation, expressed or implied, with respect to the accuracy, completeness, or usefulness of the information contained in this report, or that the use of any information, apparatus, method, or process disclosed in this report may not infringe privately owned rights; or

B. Assumes any liabilities with respect to the use of, or for damages resulting from the use of any information, apparatus, method, or process disclosed in this report.

As used in the above, "person acting on behalf of the Commission" includes any employee or contractor of the Commission, or employee of such contractor, to the extent that such employee or contractor of the Commission, or employee of such contractor prepares, disseminates, or provides access to, any information pursuant to his employment or contract with the Commission, or his employment with such contractor.

Printed in USA. Price \$ 0.75. Available from the  
Office of Technical Services  
U. S. Department of Commerce  
Washington 25, D. C.

LAMS-2959  
UC-41, HEALTH AND SAFETY  
TID-4500 (22nd Ed.)

**LOS ALAMOS SCIENTIFIC LABORATORY**  
**OF THE UNIVERSITY OF CALIFORNIA LOS ALAMOS NEW MEXICO**

REPORT WRITTEN: July 1963

REPORT DISTRIBUTED: November 15, 1963

HEALTH PHYSICS PLANNING FOR A HIGH-PRESSURE  
TRITIUM GAS EXPERIMENT AT A UNIVERSITY

Work done by:

Robert B. Day  
Robert T. Wagner  
Richard D. Hiebert  
Orin W. Stopinski  
Morris J. Engelke  
Robert Hofstadter\*  
Mason Yearian\*  
Marshall O'Neill\*

Report written by:

Morris J. Engelke

\*Leland Stanford University, Palo Alto, California.

Contract W-7405-ENG. 36 with the U. S. Atomic Energy Commission

All LAMS reports are informal documents, usually prepared for a special purpose and primarily prepared for use within the Laboratory rather than for general distribution. This report has not been edited, reviewed, or verified for accuracy. All LAMS reports express the views of the authors as of the time they were written and do not necessarily reflect the opinions of the Los Alamos Scientific Laboratory or the final opinion of the authors on the subject.

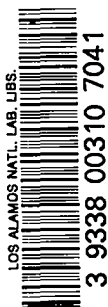



#### ABSTRACT

This paper is concerned with the problems encountered in the use of a multi-curie high-pressure tritium gas target at a large university. The necessary administrative arrangements, state licensing, transportation, and health physics problems are discussed.

#### ACKNOWLEDGMENTS

The writer takes pleasure in acknowledging the continued assistance and cooperation of the following personnel: N. E. Bradbury, Director of the Los Alamos Scientific Laboratory, whose encouragement and counsel did much to expedite the entire project; Thomas L. Shipman, Health Division Leader, for his cooperation in making his staff available for consultation on problems associated with tritium health physics problems; Donald Sandstrom for his meticulous attention to the target cell fabrication; James F. Torbert who supervised the non-destructive testing of the pressure vessels; Robert L. Mills and Don O. Coffin who were responsible for filling the pressure vessels; and other members of the LASL staff who assisted in the special problems associated with the project. Also, we were greatly assisted by Carl K. Irwin of Stanford University who helped define the health physics aspects of the project in the Palo Alto vicinity.



## INTRODUCTION

In the early fall of 1962, Leland Stanford University at Palo Alto, California, and the Los Alamos Scientific Laboratory at Los Alamos, New Mexico, began preparation to collaborate in an experiment to measure high energy electron scattering from tritium. Stanford University was to supply the high energy electron accelerator facilities (Mark III),<sup>1</sup> and LASL would undertake the construction of a high pressure tritium gas target and set up adequate health and safety procedures. The tritium experiment at Stanford University required various administrative arrangements in order to comply with internal LASL policies and regulations of the USAEC, The Interstate Commerce Commission, and the State of California. Some of the procedures followed were routine matters concerning the transfer of source and special nuclear materials, while others were necessary because of the unusual nature and quantity of the material. The integrated efforts of many experts in the field are reflected and are compiled to show the extreme precautions that were employed to ensure the success of the experiment.

---

<sup>1</sup>Review of Scientific Instruments 26 (February, 1955).

## THE EXPERIMENT

Nuclear physicists are very interested in measuring the cross sections for elastic scattering of high energy electrons. In this particular experiment the scattering of electrons from tritium would give much more sensitive details of the ground state of the triton than anything else that has been done. There are two main reasons why the scattering of high energy electrons is a valuable tool in determining nuclear structure: (1) The high energy electrons have a smaller wavelength than the nucleons previously used in tritium scattering experiments and are thus able to probe finer details of the structure of the nucleus. (2) The forces between electrons and nuclei are well understood. Therefore, the interpretation of electron scattering experiments is not hindered by the uncertainties in the forces that exist in nucleon-nucleus scattering. Thus it was hoped that important new information could be obtained on the 3-body nuclear system, and in particular on the question of whether 3-body nuclear forces exist. The initial experiments were concentrated on elastic scattering, but further details could be deduced from inelastic scattering which would be done at some future date.



The electron source was the Mark III linear accelerator at Stanford University, which will accelerate electrons to energies of 1 BeV. The average current is about 0.5  $\mu$ a although it has been run up to 1.0  $\mu$ a.

The target cell was patterned after a type that has been in use at Stanford for years. It was cylindrical shaped with hemispherical end caps of 3/4-inch diameter and an overall length of 7-5/8 inches. The cylindrical walls were 20 mil stainless steel (304), and the hemispherical end caps were of 10 mil stainless steel (304). The amount of tritium required to fill one of these cells to 1,500 psi was about 5 liters or about 12,500 curies. Figure 1 shows the components of a cell before being electron-beam welded.

After the individual parts were machined they were tested by the following diagnostic methods:

- a. Fluorescent dye penetrant,
- b. Magnetic field,
- c. Ultrasonic wave,
- d. Radiography.

These tests could reveal the presence of possible cracks, voids, inclusions, variations in heat treatment, variations in thickness, etc. Any defects thus found that might impair the strength of the parts were cause for rejecting the parts.

The vessel was then assembled and welded together by electron-beam welding. This technique produces a joint that has the same properties as

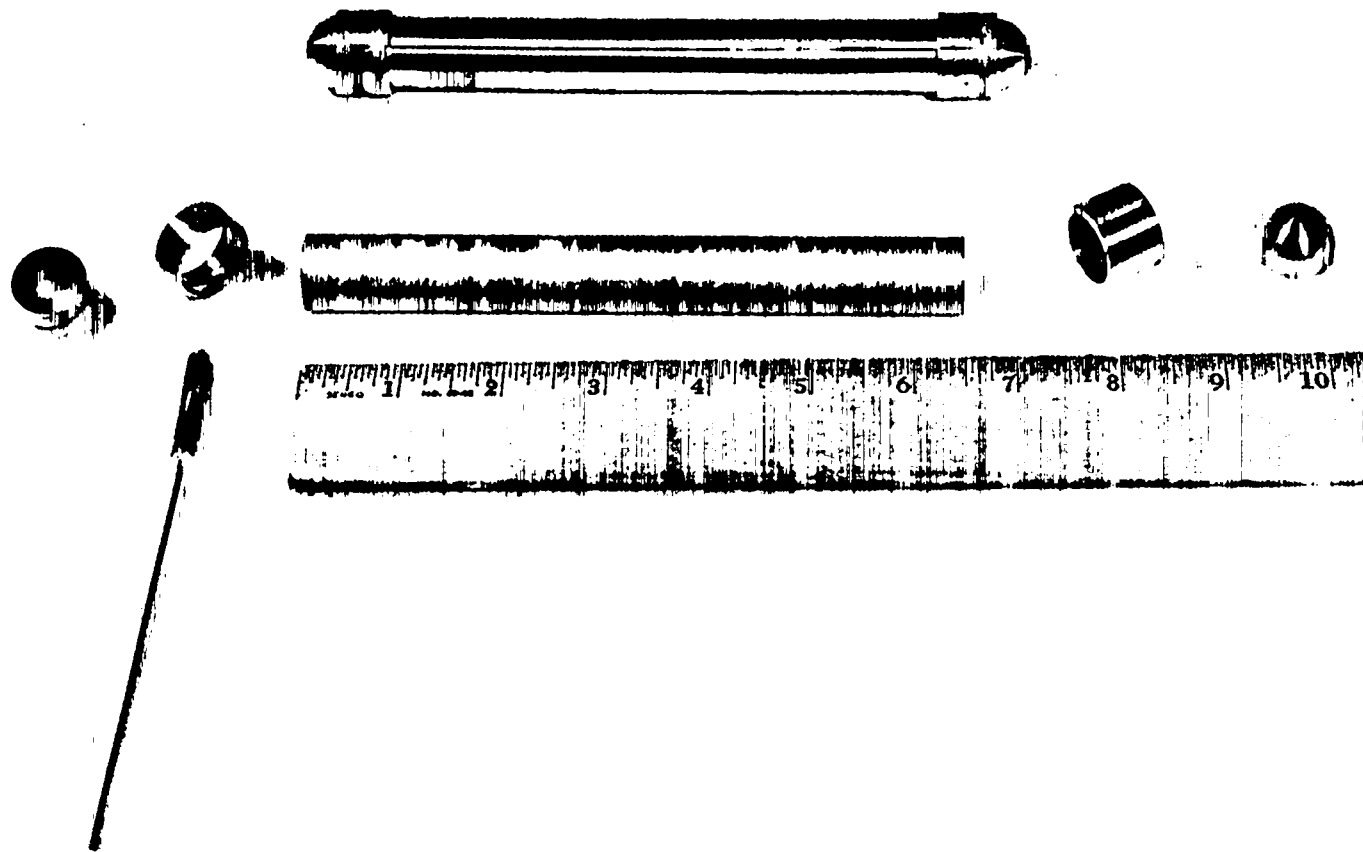

8

Figure 1. Target cell components.

the metal itself and also produces a more reliable and leak-free joint than is possible by other methods.

The vessels next had the capillary filling lead brazed on and were then helium leak tested at a pressure of 1,500 psi. If leak-tight they were again radiographed to be sure that all the welds were sound.

The next test was a pressure test in which the variation in axial length and diameter was measured as a function of pressure. For two of these vessels this test was carried out at increasing pressures until the vessels broke. The vessels chosen were not quite typical since they had small defects that made them appear undesirable for tritium use. Thus the results below can probably be considered as lower limits.

	Vessel #1	Vessel #2
Pressure at rupture	4,050 psi	4,170 psi
Pressure at 0.2% yield	3,200 psi	2,825 psi

Figure 2 shows the result of pressure tests to rupture of the target cell components.

Then one of the satisfactory vessels, inside its mounting bracket, was filled with hydrogen to 1,500 psi and dropped several times from a height of 3 to 4 ft to the floor on end, on side, and on corner. Post-drop examination showed that, although the mounting bracket was dented, the vessel survived in satisfactory condition, that is, remained leak tight. In addition to this, studies have been made on hydrogen embrittlement of #304, and this steel was found to be satisfactory. Calculations of the heat generated from 12,500 curies of tritium and

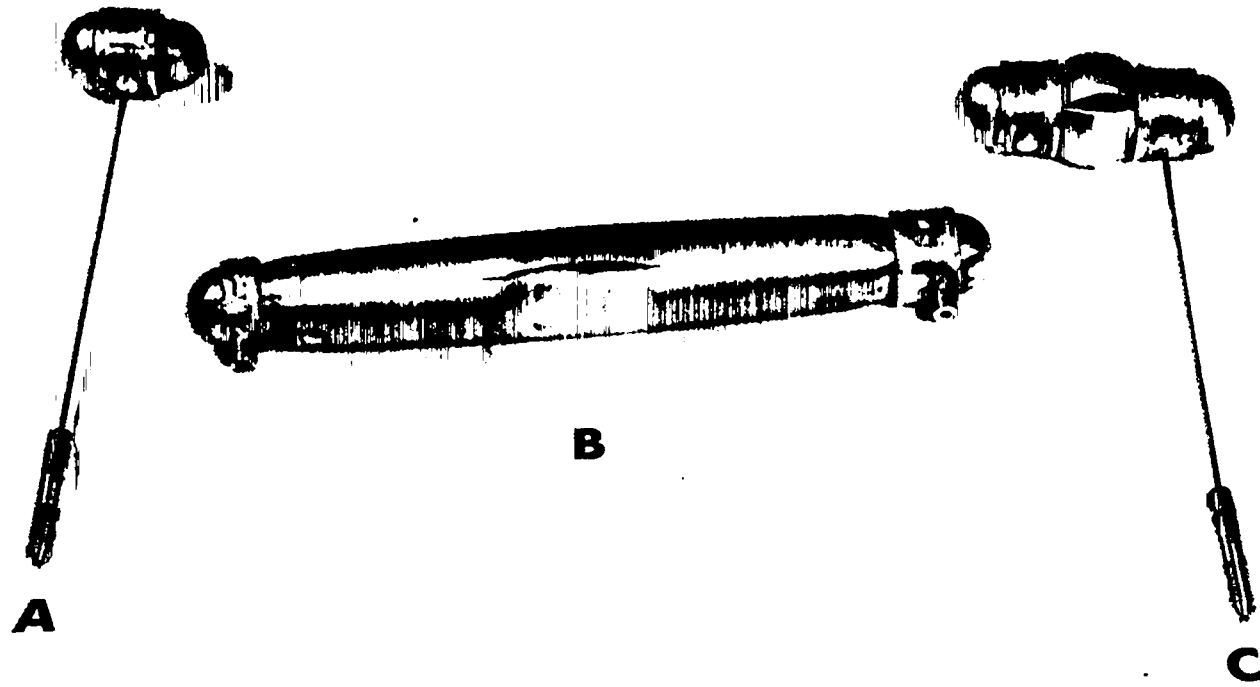

Figure 2. Pressure tests to rupture.

from the electron beam heating, which dissipated in the metal assembly, gave 0.3 and 1.0 watts, respectively.

Two of the satisfactory vessels were filled with tritium to 1,500 psi. The capillary filling tubes of the filled vessels were pinch-welded shut about 1 inch from the body of the vessels and the remainder of the filling tube and valve removed. For reasons of safety, the welds were made from a position considerably removed from the welder; and during the welding process, a quenching gas was blown on the weld area to prevent a fire from occurring. Tritium monitoring of the filled vessels began immediately, and a daily record of the results was kept for each filled vessel.

#### TRANSPORTATION

Pressurized shipping containers were prepared for movement of the target vessels to Stanford (Fig. 3). The ICC regulations required Bureau of Explosive approval for a shipping container used to transport more than 2.7 curies of tritium gas under pressure; this was obtained after certain changes in the container. The Bureau of Explosives also required controlled, escorted transport of the container from Los Alamos, New Mexico, to Stanford, California.

The available shipping containers, which were previously used for shipment of other materials and were modified for this problem, had a thin aluminum cylindrical cover about 2 inches in diameter on the top and the bottom of the container. These covers had to be replaced with a solid weld before meeting the Bureau of Explosive approval.

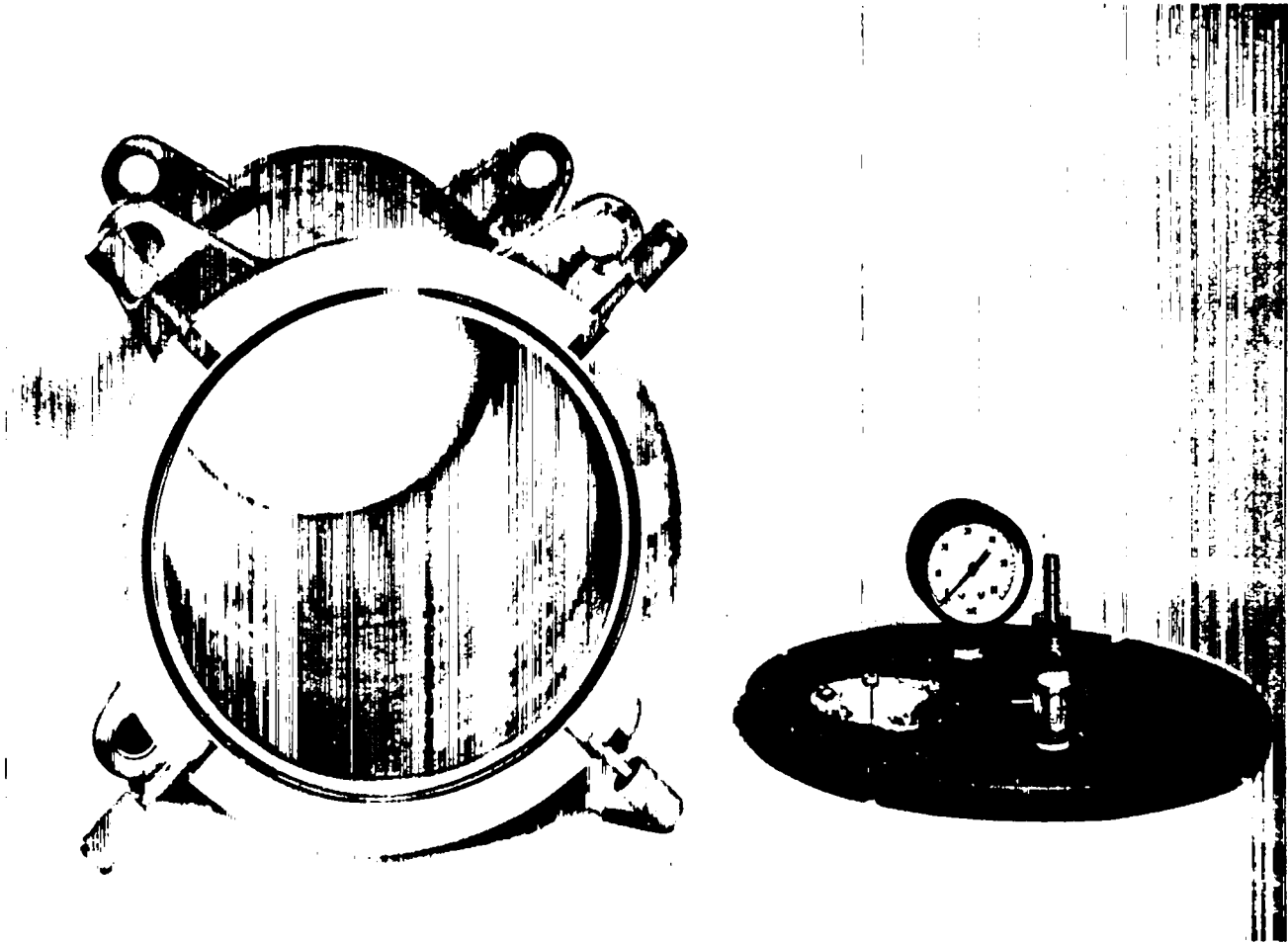

Figure 3. Shipping container.

These containers were provided with a filling valve and pressure gauge. The filled tritium vessel was placed inside its mounting bracket and the bracket surrounded with a fitted styrofoam cushion whose exterior dimensions were the same as the shipping container inner diameter (Fig. 4). The vessel, bracket, and cushion were placed in the shipping container and the container pressurized to ~ 5 psig. The shipping container was tritium monitored after a period of one day by sampling the exhaust from the pressure nozzle on the container. If no leaks were detected the shipping container was repressurized and readied for shipment.

Carco Air Service, an AEC contract airline, supplied a Beechcraft Twin Bonanza for an exclusive-use flight to transport the tritium to Stanford University. The aircraft was checked in advance to determine that the shipping containers could be securely tied down in the baggage compartment. Carco supplied information concerning the Palo Alto and San Jose airports. Both of these airports were inspected, and the routes to the Stanford University campus were determined in advance. The actual flight was scheduled so as to arrive at the destination during the time of minimum traffic congestion on the freeway. Stanford University provided a truck and a station wagon and the necessary drivers in order to move the tritium and the LASL personnel from the airport to Stanford University.

The shipment was made May 8, 1963, and consisted of two containers of tritium totaling 22,156 curies, one container of helium 3, and one of hydrogen. Upon arrival at Stanford University the containers were inspected

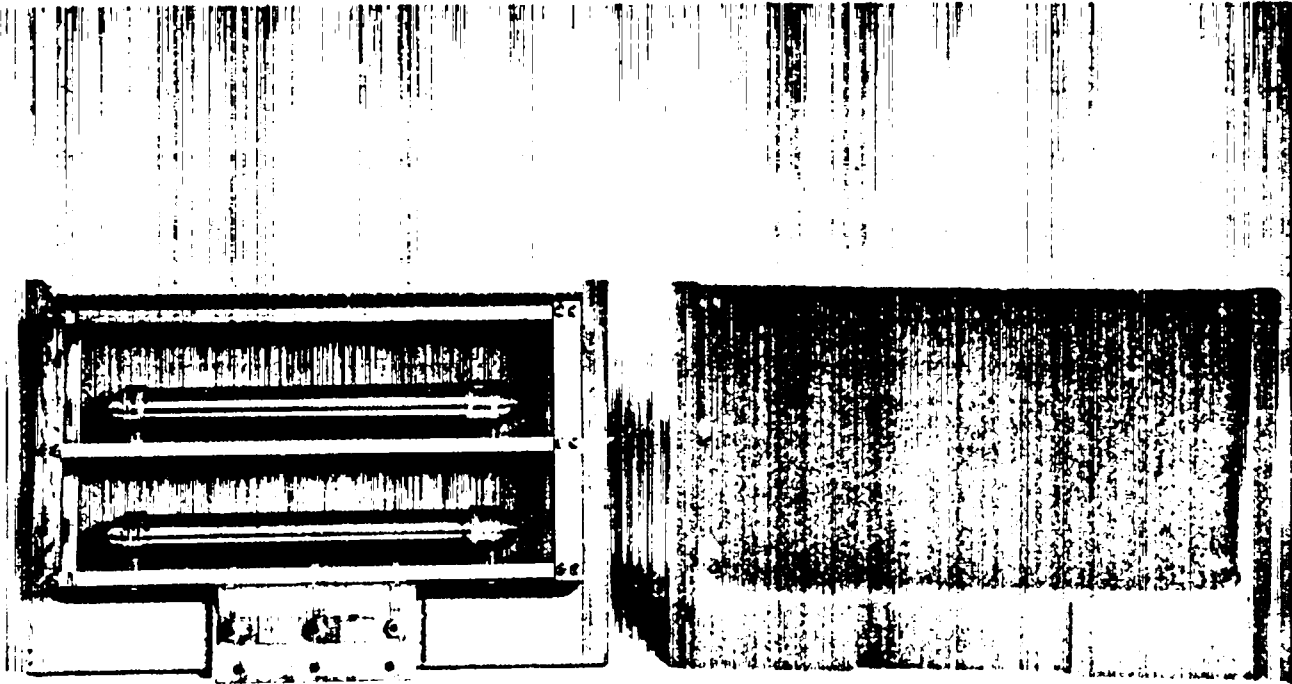

Figure 4. Targets in styrofoam packing.



and the internal pressure noted with due account made for the change in elevation. The type of gauge used measured a differential in pressure from the inside of the container to the outside atmospheric pressure. A sample at the exhaust valve then was monitored for tritium. These results were negative. The container was closed and put in a locked storage cabinet, vented to the outside, until the experiment was ready to be started.

The action to be followed if a tritium leak were detected any time the pressure vessels were within the shipping container was to close the filling valve, assure that the container was leak tight, and return the vessels to Los Alamos by the most expeditious means available.

#### INSTRUMENTATION

The bremsstrahlung background radiation associated with accelerators varies with machine operating conditions such as beam energy, beam current, beam focusing, etc. In general the monitoring of low energy tritium betas ( $\sim 20$  keV) is difficult where gamma or neutron induced activities exist. Existing tritium detection instruments that employ ion traps or are equipped with gamma compensated mechanisms have not proved desirable around accelerators. Therefore a philosophy of monitoring was adopted in which the sensitivity of the instrument was adjusted to a large quantity released on a one-shot basis. The radiation levels in the end station were originally estimated to be in the 10 mr/hr to 100 mr/hr

region but subsequently proved to be from 10 r/hr to 100 r/hr. This was attributed to the fact that this area is an exclusion area during machine operation, and the occasion for measurement had not been urgent. With a background of 10 mr/hr in mind, the Model 123 multi-station air sampler was designed and constructed (Figs. 5 and 6). The detectors were patterned after the Model 101 tritium sniffer; but instead of using a sensitivity selector switch, this instrument was arranged to cover 3 decades with sensitivity as shown in Figure 7. The unique advantage of this type of instrument was that the alarm point could be set slightly above whatever background was encountered. Since we were not concerned with knowing tritium concentrations but only knowing that there was any tritium at all, this system was very simply installed and adequate. With a background of 10 r/hr it was necessary to shield the detectors with lead.

There were three detectors with local alarms at the detector, alarm and read-out at the counting room, and an alarm at the control room (Figs. 8 and 8a). One detector was placed about 15 feet from the scattering chamber, a second at the tritium storage area, and a third was tied into the vent stack with an ion pre-collector and as far away from the scattering chamber as possible. The reset for these detectors was located in the counting room. Stand-by portable tritium detectors were available in case of trouble. Tritium urinalysis of all personnel was made on a routine basis.

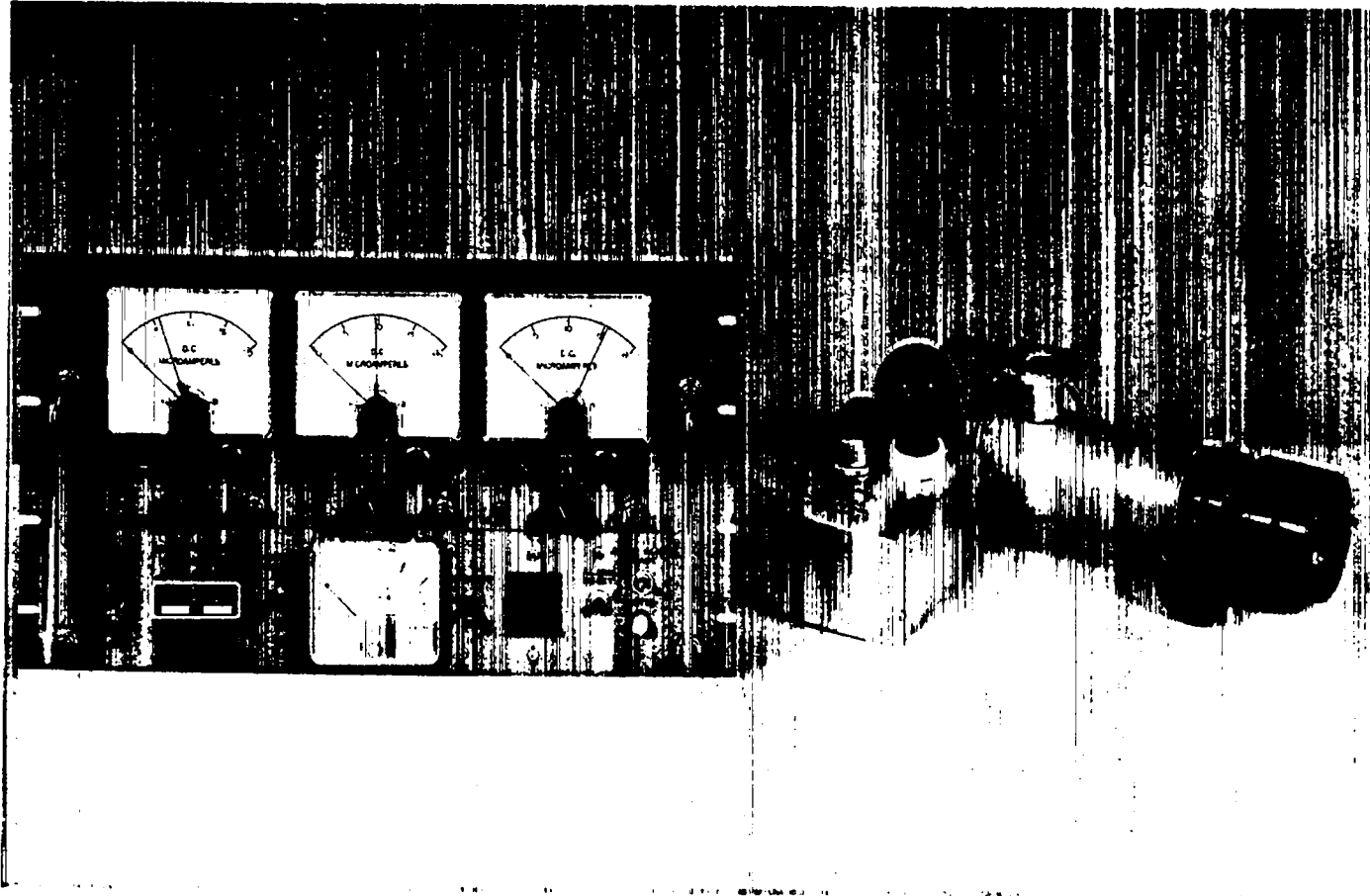

Figure 5. Multi-station air sampler.

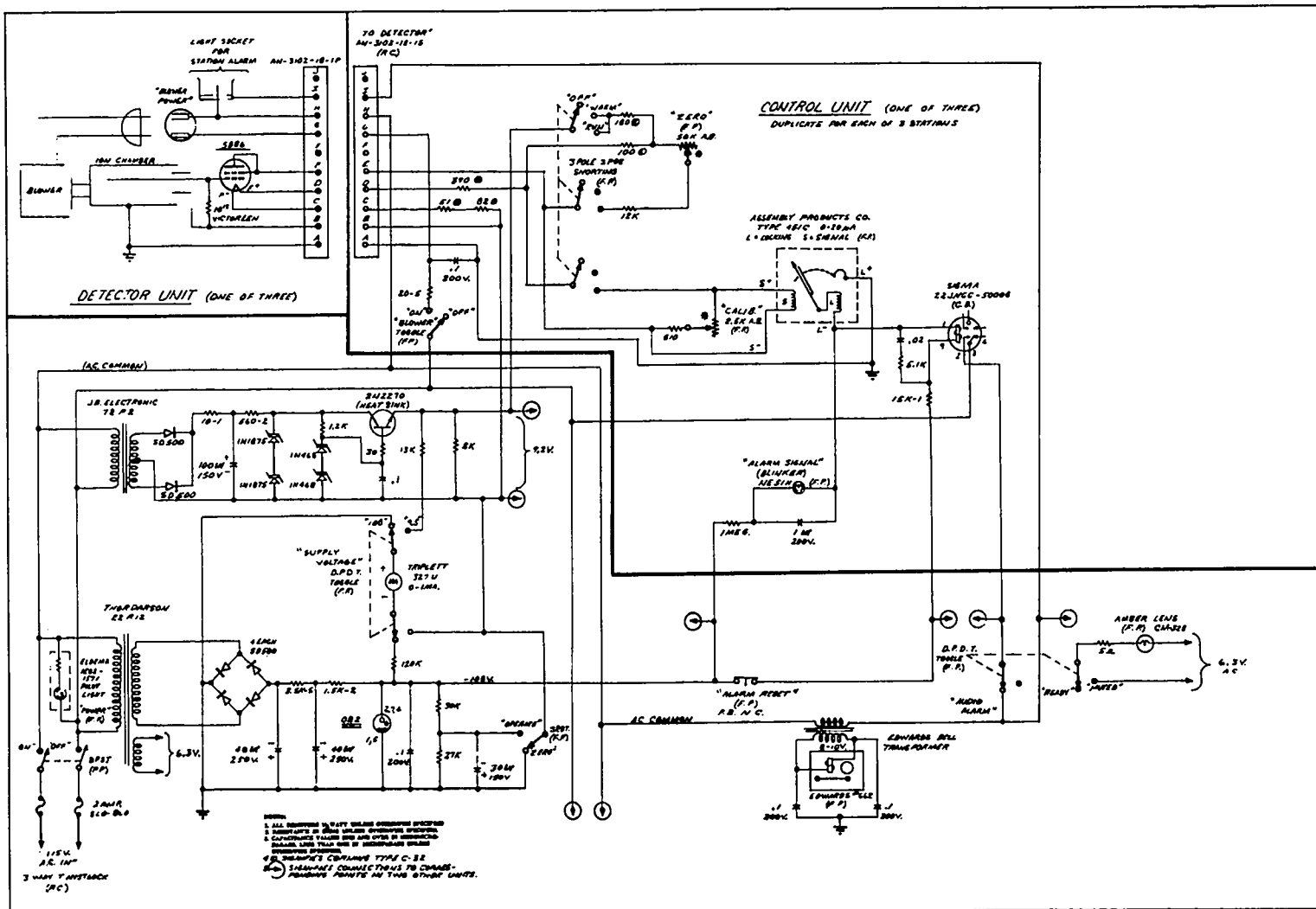

Figure 6. Wiring schematic.

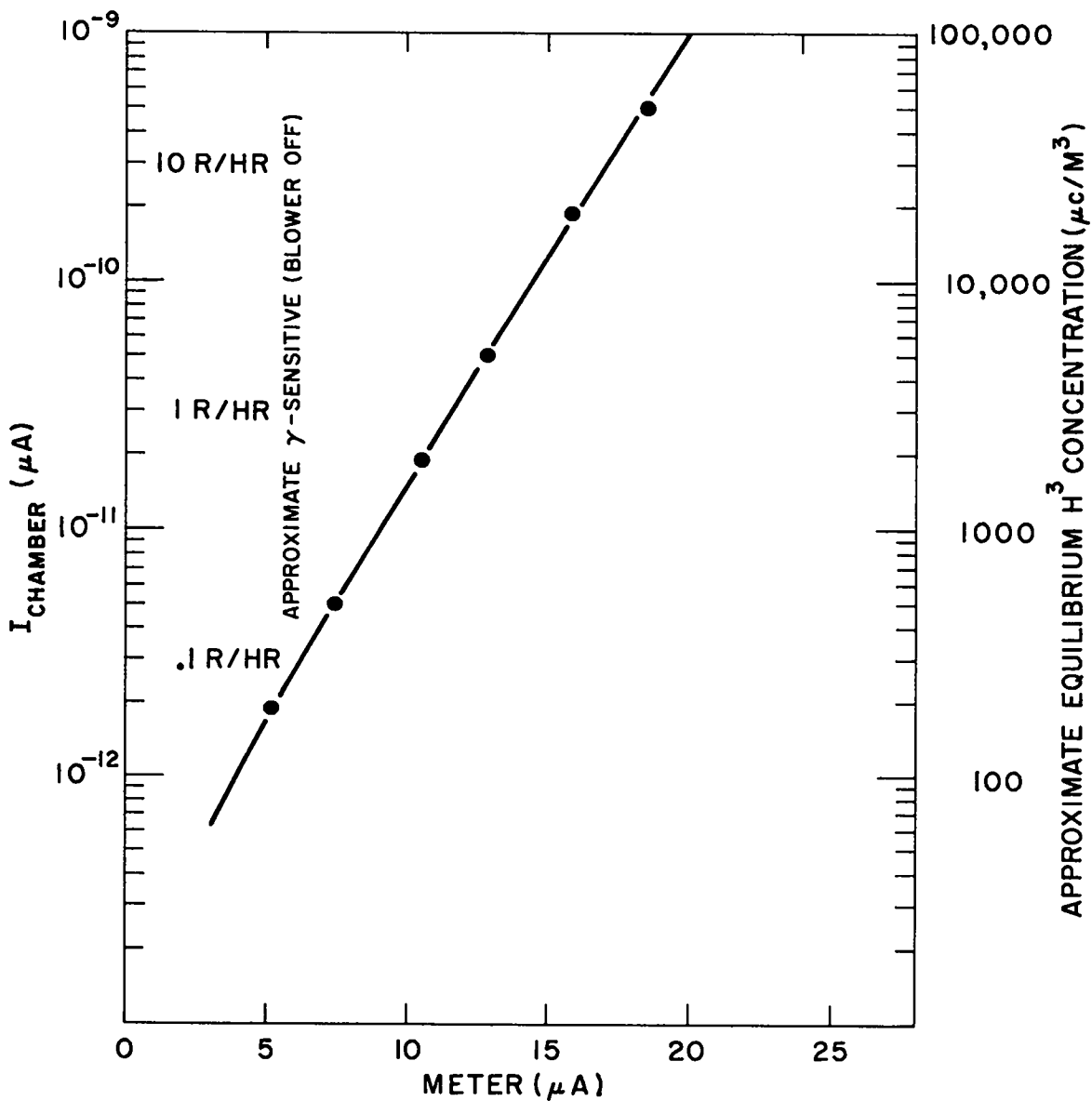

Figure 7. Model 123 air sampler current calibration, plus approximate  $\gamma$  and  $\text{H}^3$  calibration.

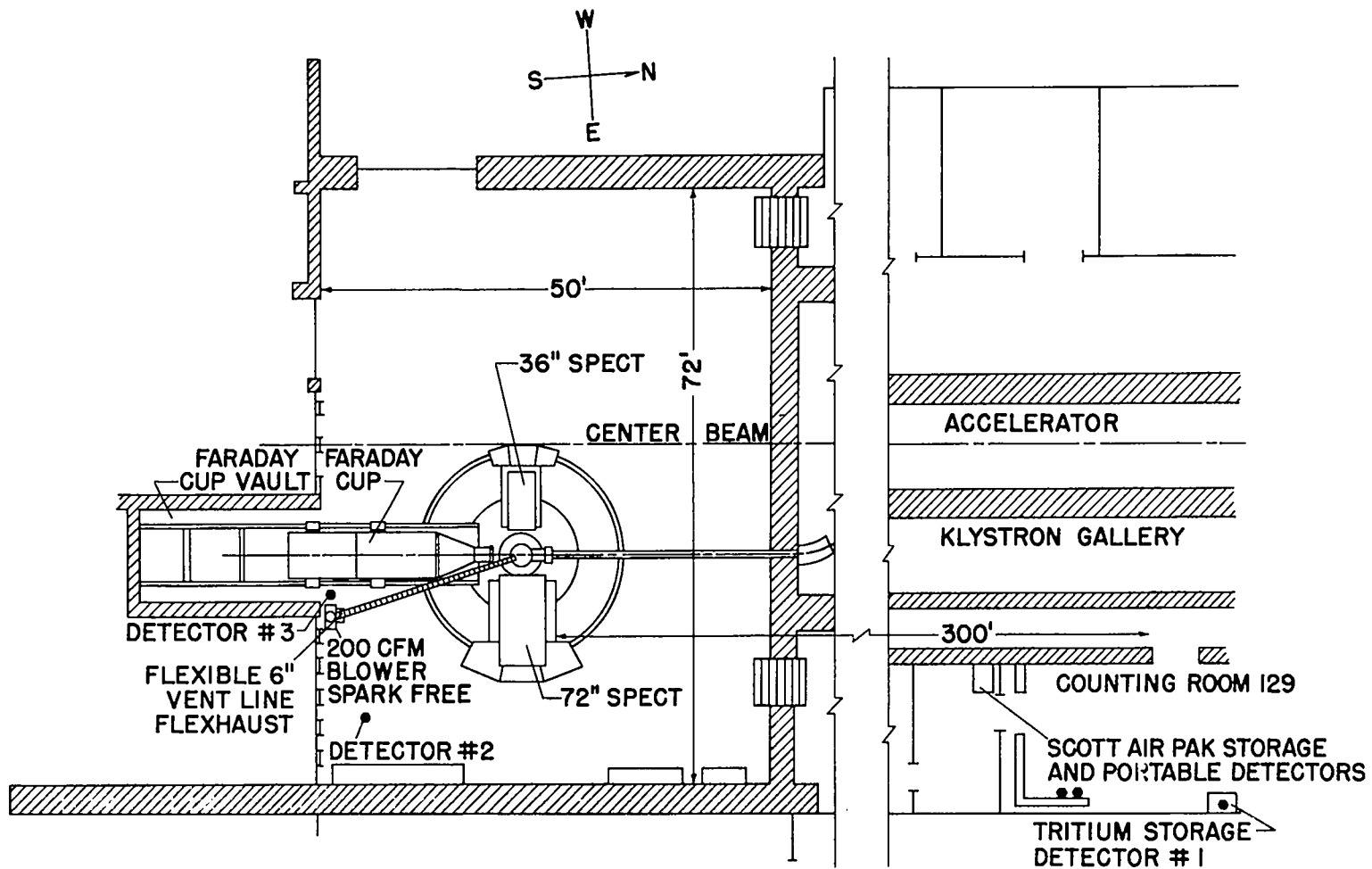

Figure 8. Tritium experiment layout (floor plan).

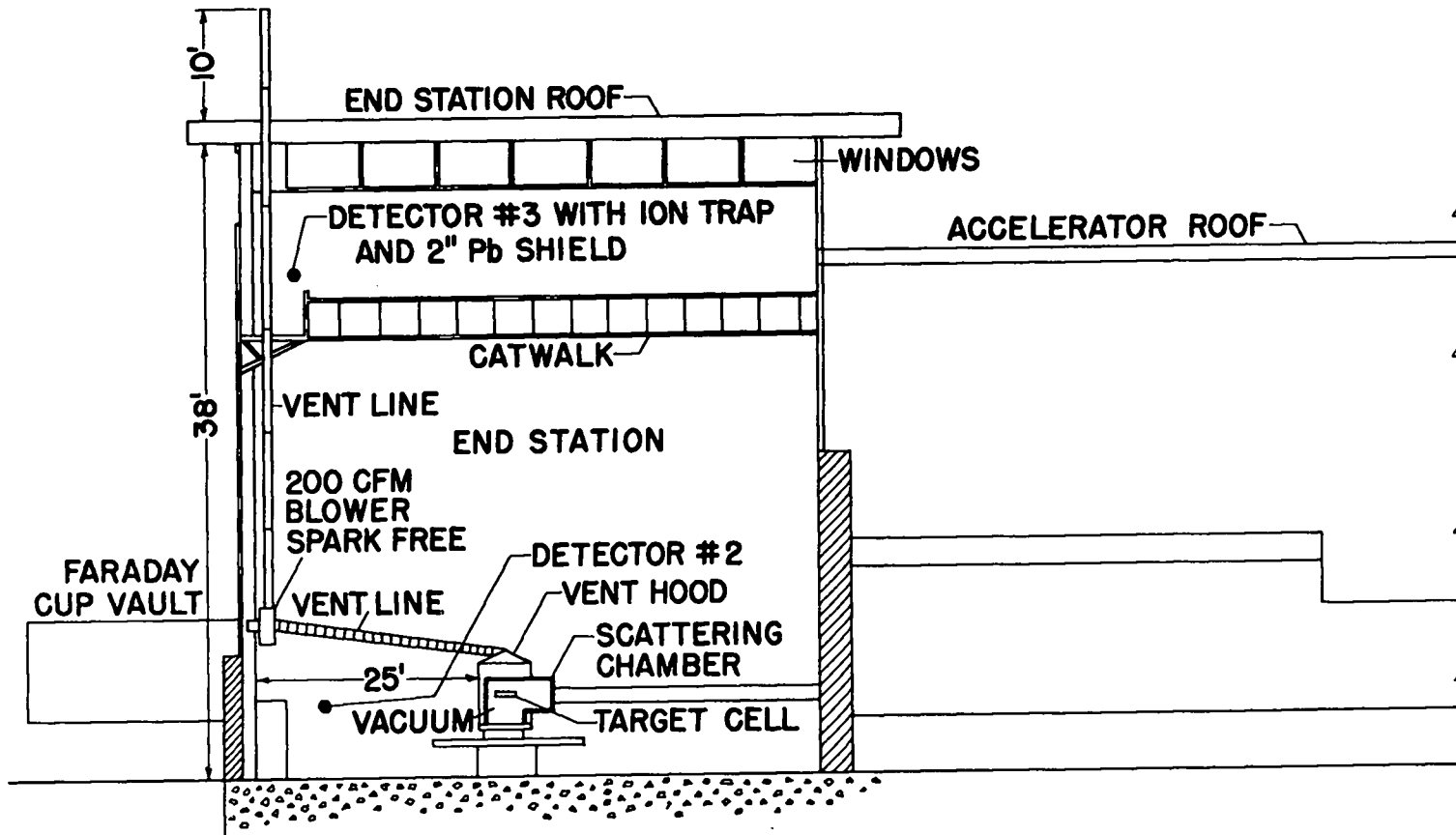

Figure 8a. Tritium experiment layout (west elevation).

## DISCUSSION OF POSSIBLE ACCIDENT

The scattering chamber was 18 inches in diameter and 10 inches in height. It was evacuated prior to and during each run (Fig. 9). The exhaust of the pumps was connected to the main vent line, which discharged into the atmosphere at a point 50 feet above ground level. A venting hood (Fig. 10) was fitted over the entire scattering chamber, and this also was connected to the main vent line. The overall installation, with the hood in place, including the spectrometer, is shown in Figure 11. If the target vessel were to leak during an experimental run, the ion vacuum gauge would trigger an automatic quick action valve which would trap the tritium in the vacuum system. The tritium would then be diverted to a large evacuated gas cylinder and held for subsequent disposal.

If the mounting bracket were to be dropped on transfer from the shipping container to the scattering chamber, no rupture would be expected unless a pointed object would somehow puncture the vessel. This would be the worst situation. Although every effort has been made to prevent trouble the possibility of accident existed. In this event the population density and possible exposures have been considered; these subjects are considered in detail in the next section.



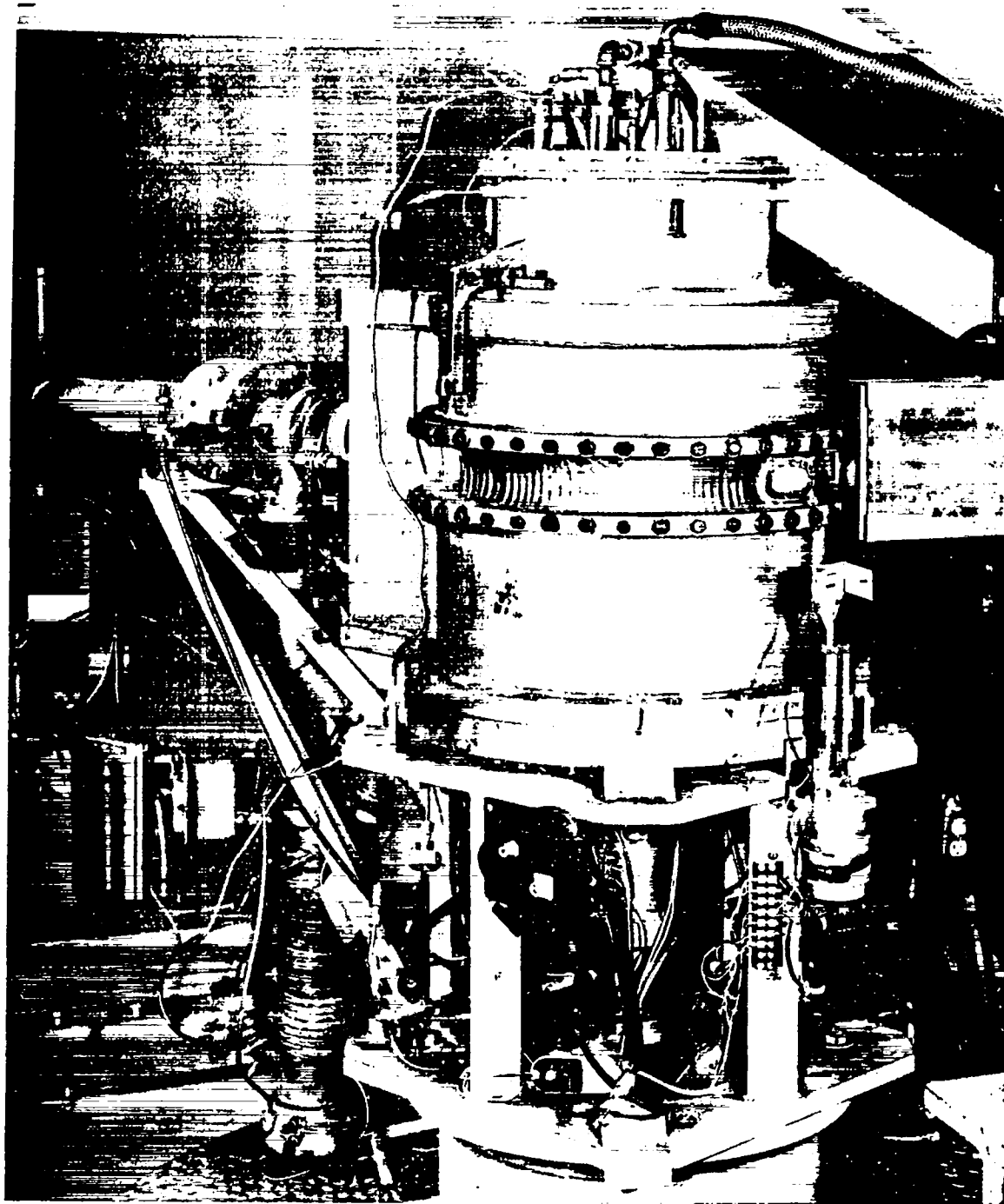

Figure 9. Scattering chamber.

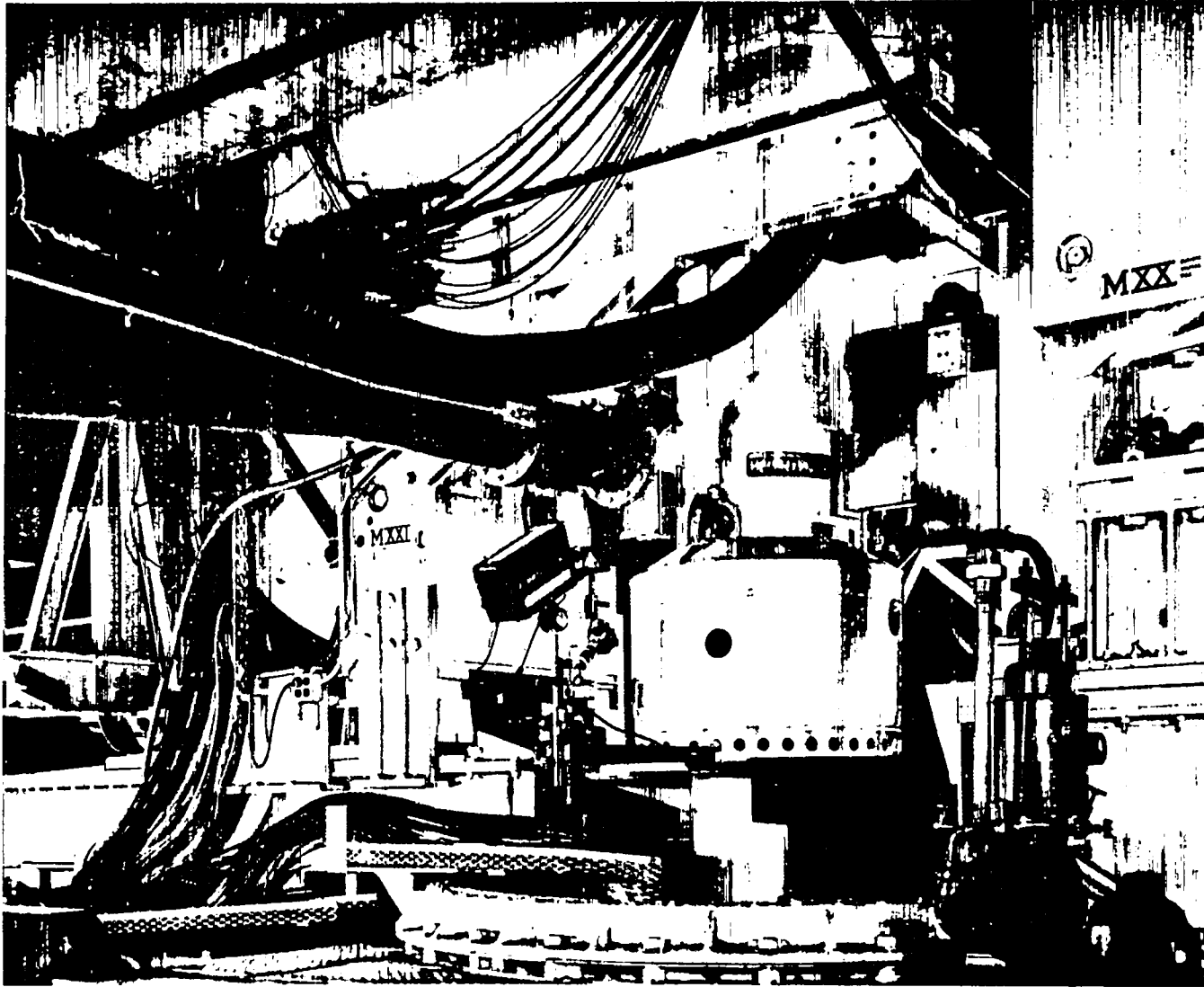

Figure 10. Venting hood over scattering chamber.

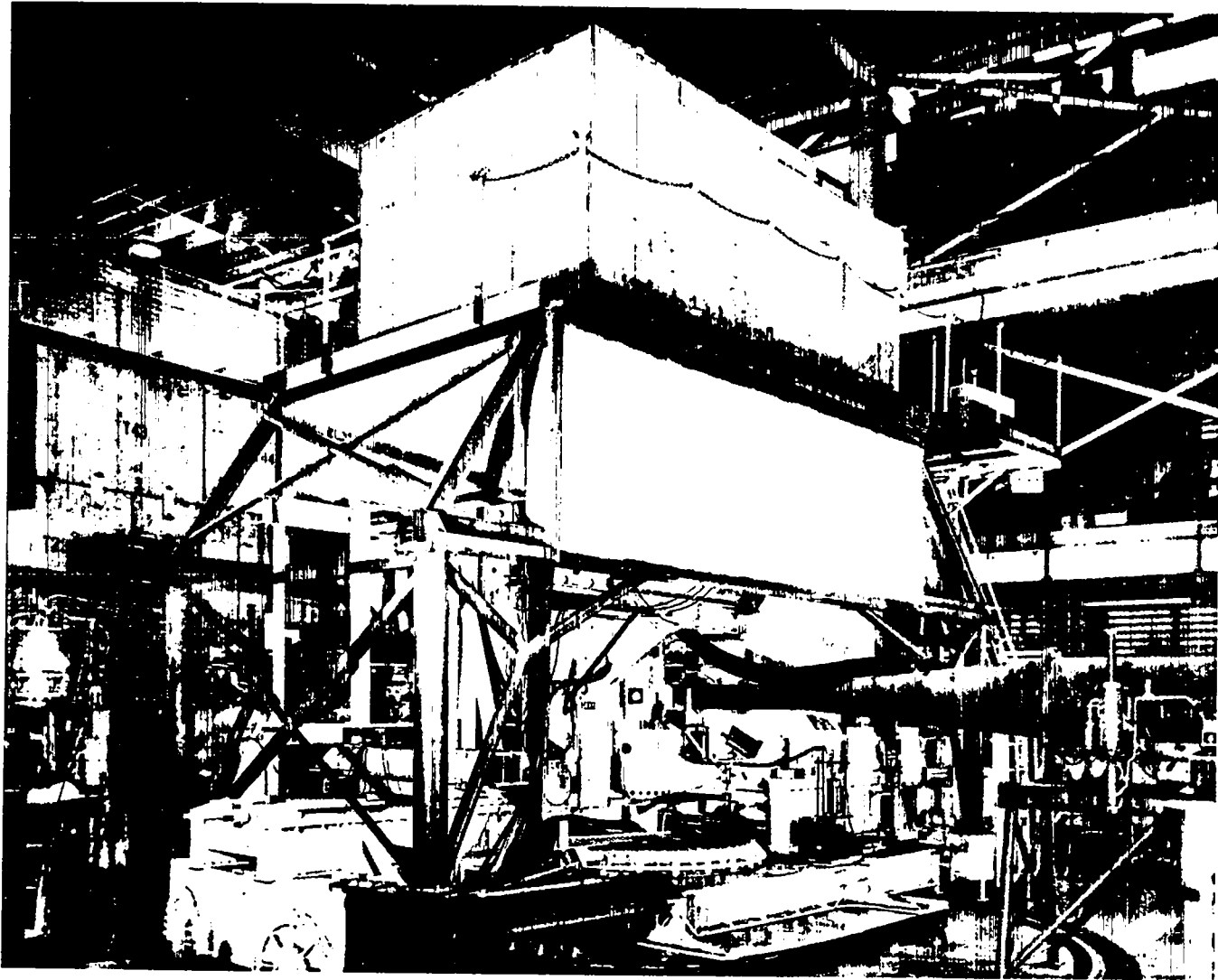

Figure 11. Overall installation at end station.

POPULATION DENSITY AND POSSIBLE EXPOSURES IN THE VICINITY  
OF THE END STATION

In the unlikely event a rupture of the target vessel should occur, it becomes important to know how many persons might be exposed to tritium, and what their total exposure would be under various conditions. Figure 12 shows the population density around the accelerator at three distances. The 37 meter area would have not more than 10 persons, all of whom are radiation workers. Non-radiation workers are in the 400 and 1,200 meter areas. Since the experiment is run at night time or on weekends when there is a minimum number of people on the campus in the vicinity of the end station, an estimate of 1,000 persons in the 400 meter area and 10,000 persons in the area of 1,200 meters was made.

Stopinski's calculations are used for estimating the possible exposure due to the release of tritium in the atmosphere and are quoted here.<sup>2</sup> "Should all of the tritium react so the atoms are present in water molecules, a non-worker could be exposed to a one-quarter exposure at a distance of 430 meters. In all probability the distance to one-quarter exposure would be much closer to 37 meters, since the tritium reacts relatively slowly, and during the time practically all of the tritium would be present as free molecules."

At the 400-meter radius the only problem could concern the two women's dormitories, Lagunita Court and Roble Hall, with a total population of 600 women. There are no other night residents in the entire area.

<sup>2</sup>See Appendix.

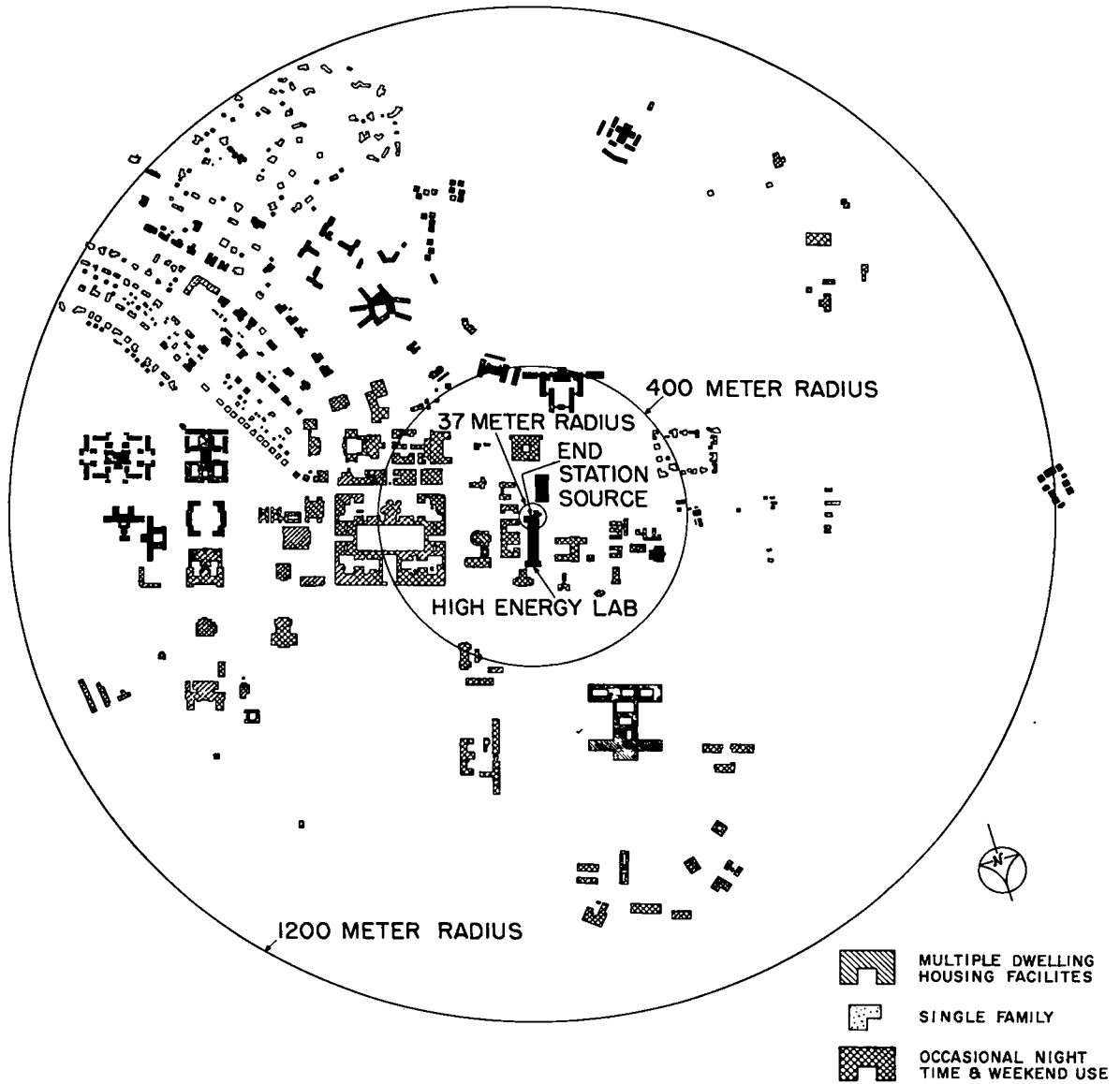

Figure 12. Stanford area population density.

The above information was submitted to the State of California; and with these data Stanford University was able to obtain the necessary license under Title 17, California Health and Safety Code. Then the San Francisco Operations Office (SAN), USAEC, was asked by LASL for permission to ship up to 25 liters of tritium gas to Stanford University. Permission was granted after SAN was assured that health and safety considerations had been complied with by Stanford and after Stanford had received a State of California license to cover this quantity of radioactive materials.

#### SUMMARY

This experiment has been in progress for four months and demonstrates that large amounts of tritium at high pressure can be safely used at universities. In a high hazard experiment of this kind, careful planning is essential, and all aspects must be thoroughly investigated.

## APPENDIX

In estimating the possible exposure due to the release of tritium into the atmosphere, use has been made of the integrated Sutton equation for air concentration. In this form the Sutton equation becomes:

$$\text{TID} = \frac{2Q}{\pi C^2 \bar{u} (\bar{u}t)^{2-n}} \exp - \frac{h^2}{C^2 (\bar{u}t)^{2-n}}$$

TID = Total Integrated Dose

where

Q = amount of material released (here microcuries),

$\bar{u}$  = mean wind speed in meters per second,

t = time in seconds,

( $\bar{u}t$  then becomes distance),

C = the generalized diffusion coefficient,

n = the stability index of the atmosphere,

h = the height of release above the surface in meters.

The following assumptions have been made in preparing the curve of TID versus distance:

- (1) release point is at the surface,
- (2) C is taken to be 0.1,
- (3) n is taken to be 0.25,
- (4) the mean wind speed is taken to be 5 meters per second,
- (5) Q =  $1.24 \times 10^{10}$  microcuries.

Assumption (1) reduces the basic equation to the form of

$$\text{TID} = \frac{2Q}{\pi C^2 u (\bar{u}t)^{2-n}}$$

Use of the values as made in assumptions (2) through (5) results in the curve as shown in Figure A-1, of Total Integrated Dose (Exposure) in microcurie-seconds per cubic meter.

The curve of TID versus distance may be used for any other wind speed by multiplying the TID at any point on the curve by the ratio of 5 to the appropriate wind speed (e.g., doubling the wind speed to 10 meters per second reduces the TID to one-half the value shown on the curve).

The curve of TID becomes far more meaningful when interpreted in terms of permissible exposure. Handbook 69, National Bureau of Standards, U. S. Department of Commerce, gives two values for continuous exposure to tritium. For gaseous tritium, a worker may be exposed continuously to a concentration of  $4 \times 10^{-4}$  microcuries per cc. For tritium water the limit is lowered to  $5 \times 10^{-6}$  microcuries per cc. Converting these concentrations to continuous exposure for a quarter, it is noted that for the case of free tritium the total permissible exposure is  $3.14 \times 10^9$  microcurie-seconds per cubic meter, and for tritium water the total permissible exposure is  $3.93 \times 10^7$  microcurie-seconds per cubic meter.

The assumption is made that for uncontrolled populations, exposure must be reduced by a factor of 10. These four points are clearly marked on the TID curve.



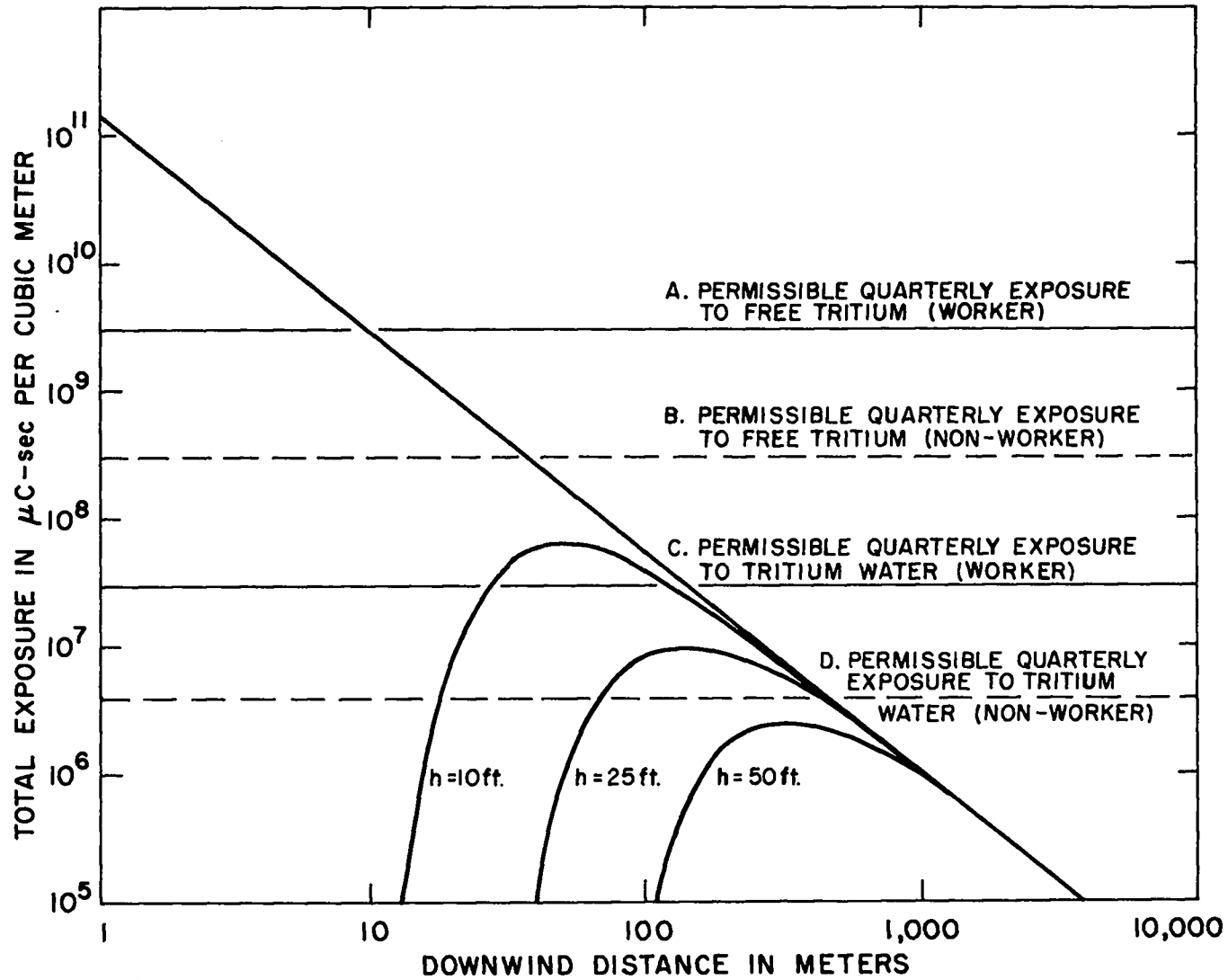

Figure A-1. Tritium exposures vs distance.

If the curve is taken at face value, it is possible to state that should 12,500 curies of tritium be released at the surface in a 5 meter per second wind a non-worker, standing directly downwind at a distance of 37 meters, could be exposed to a total dose equivalent to that permitted in one quarter. Should all of the tritium react so the atoms are present in water molecules, a non-worker could be exposed to a quarter's exposure at a distance of 430 meters. In all probability the distance to one quarter's exposure would lie much closer to 37 meters, since the tritium reacts relatively slowly, and during the time of interest practically all of the tritium would be present as free molecules.

It should be noted here that it is generally accepted that computations based on Sutton's equation have a 95% probability of being within one order of magnitude of the true value.